



# Technical Manual

# STEREO POWER AMPLIFIER RB-1090-3

### Table of Contents

- Specification.....1
- Parts List.....2 ~ 6
- Adjustment.....7 ~ 8
- PCB Assembly.....9
- Schematic Diagram.....10

### Specification

|  |  |
|--|--|
| Continuous Power Output<br>(20-20kHz, < 0.03%) | 380 wats/ch into 8 ohms<br>700 wats/ch into 4 ohms |
| Total Harmonic Distortion(20-20kHz, 8 ohms)    | < 0.03 %   |
| Intermodulation Distortion(60Hz : 7kHz, 4:1)   | < 0.03 %   |
| Frequency Responce ( 1dB)                      | 10 Hz - 100 KHz                                    |
| Dampning Factor(20-20,000kHz, 8 ohms)          | 1000   |
| Speaker Impedance(combined load)               | 4 ohms minimum                                     |
| Signal to Noise Ratio(IHF A network)           | 125 dB   |
| Input Impedance / Sensitivity                  | 33 k ohms / 1.8 volt                               |
| Power Requirement                              | 115 volts 60 Hz or<br>230 volts 50 Hz              |
| Power Consumption                              | 800 watts  |
| Dimensions(W x H x D)                          | 432 x 237 x 406 mm<br>17 1/8 x 9 3/9 x 15 inches   |
| Panel Height                                   | 221 mm   |
| Weight (net)                                   | 38 kg, 83.6 Lb.                                    |

## THE ROTEL CO., LTD

BUNZAN-SHINSEN-BLD. 4F 10-10 SHINSEN-CHO, SHIBUYA-KU,  
TOKYO 150-0045, JAPAN

Serial. NO.  
Begining 2311001

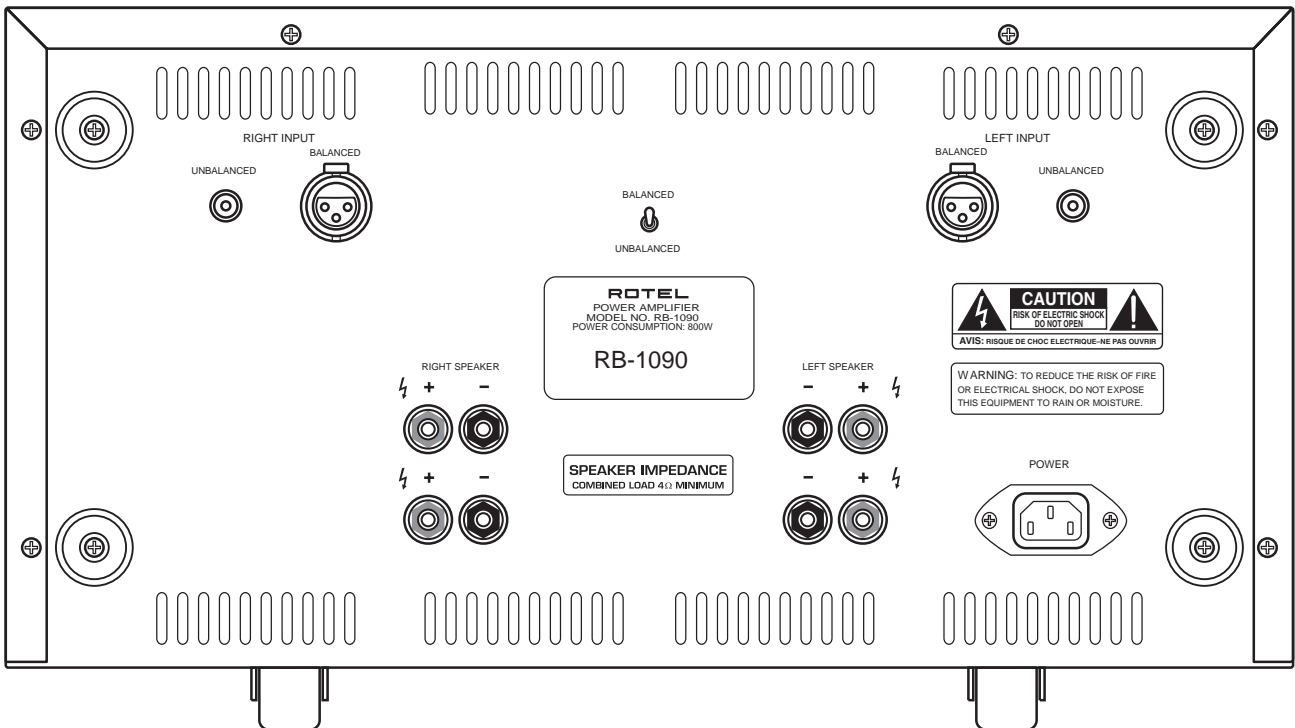
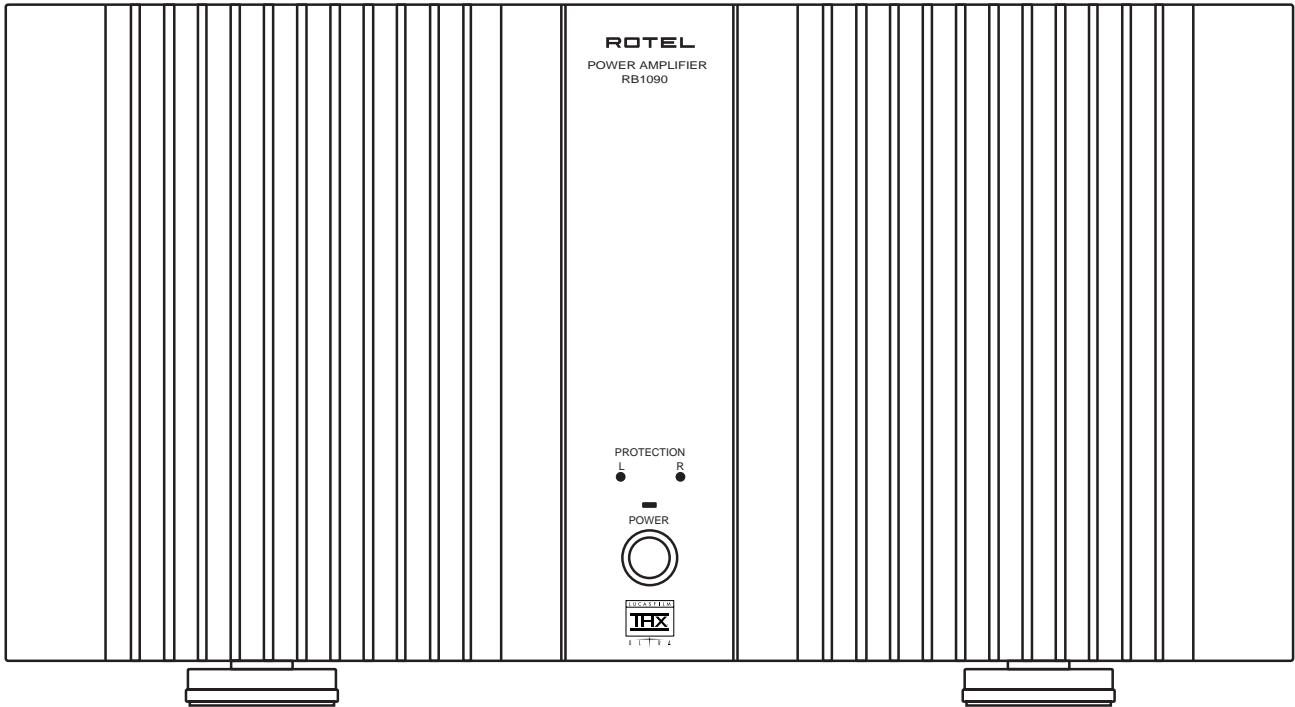

| SYMBOL                           | PARTS NO.         | DESCRIPTION                        |
|----------------------------------|-------------------|------------------------------------|
| <b>016 X-1271D01-08 PCB ASSY</b> |                   |                                    |
|                                  | 501 X-1271D       | PCB ASSY                           |
| L601-602                         | 021 TRL-380       | SPEAKER COIL 1.6F 9T               |
| IC701,702                        | 031 MPC1237HA     | IC (PROTECTION)                    |
| IC501,502                        | 031 OPA134PA      | IC (OPEAMP)                        |
| Q621,622                         | 032 A1932         | TRANSISTOR 2SA1932                 |
| Q619,620                         | 032 C5174         | TRANSISTOR 2SC5174                 |
| Q613,614,667,668                 | 033 A1209-ST      | TRANSISTOR 2SA1209-ST              |
| Q902                             | 033 B631-EF       | TRANSISTOR 2SB631K-EF              |
| Q615,616,669,670                 | 033 C2911-ST      | TRANSISTOR 2SC2911-ST              |
| Q901                             | 033 D600-EF       | TRANSISTOR 2SD600K-EF              |
| Q607-612,657-662,747-750         | 033 TA1016-FG     | TRANSISTOR 2SA1016KAA-FG           |
| Q751-754                         | 033 TA1376A-LKU   | TRANSISTOR 2SA1376AT-LKU           |
| Q601-606,651-656,745,746         | 033 TC2362-FG     | TRANSISTOR 2SC2362KAA-FG           |
| Q755-758                         | 033 TC3478A-LKU   | TRANSISTOR 2SC3478AT-LKU           |
| D609-612,903,904                 | 034 T1N4003-TB    | DIODE 1N4003-E                     |
| D601-608,615,616                 | 034 T1N4148-86    | DIODE 1N4148TAP-50                 |
| D701,702,713,714                 | 034 T1N4148-86    | DIODE 1N4148TAP-50                 |
| D751-754                         | 034 T1N4148-86    | DIODE 1N4148TAP-50                 |
| D905,906                         | 034 TRD16JST1     | ZENER DIODE 16V (AB2)              |
| D902                             | 034 W02M          | POWER DIODE 1.5A200V               |
| C910,911                         | 041 25BGF470M     | ELECTROLYTIC CAPACITOR 25V470uF    |
| C611,612                         | 041 35ZA10MTZ     | ELECTROLYTIC CAPACITOR 35V10uF     |
| C601,602                         | 041 35ZA4R7MTZ    | ELECTROLYTIC CAPACITOR 35V4.7uF    |
| C607,608,505-508                 | 041 TEEUFC1E101SB | ELECTROLYTIC CAPACITOR 25V100uF    |
| C703,704                         | 041 TUTES1E221-TF | ELECTROLYTIC CAPACITOR 25V220uF    |
| C707,708                         | 041 TUTES1E470-TF | ELECTROLYTIC CAPACITOR 25V47uF     |
| C717,718                         | 041 TUTES1H100-TF | ELECTROLYTIC CAPACITOR 50V10uF     |
| C701,702                         | 041 TUTES1H220-TF | ELECTROLYTIC CAPACITOR 50V22uF     |
| C705,706                         | 041 TUTES1H4R7-TF | ELECTROLYTIC CAPACITOR 50V4.7uF    |
| C903,904                         | 041 TUTES1J221-TS | ELECTROLYTIC CAPACITOR 63V220uF    |
| C623-626                         | 041 VX2A102S      | ELECTROLYTIC CAPACITOR 100V1000uF  |
| C709,710                         | 042 TP50V223J     | MYLAR CAPACITOR 0.022uF            |
| C613-616                         | 044 FSC160V221H   | STYROL CAPACITOR 160V220pF         |
| C627,628                         | 044 FSC160V471H   | STYROL CAPACITOR 160V470pF         |
| C691,692                         | 044 KT18-2E104J   | MP CAPACITOR MKT1818-410/254       |
| C501,502                         | 044 S50V100PJ     | STYROL CAPACITOR 50V100pF          |
| C603,604                         | 044 TFKP2-2A681H  | P.P CAPACITOR FKP2-100V681H        |
| VR601-604                        | 051 SFR001-222    | SEMI-FIXED RESISTOR VM6CKPH1S-2.2K |
| R1                               | 054 ERQ2ABJP220S  | FUSE RESISTOR 2W 22                |
| R777,778                         | 054 TMFR401K2     | METAL FILM RESISTOR 1/4W 1.2K      |
| R607-610,615-618,908,909         | 054 TMFR401K5     | METAL FILM RESISTOR 1/4W 1.5K      |
| R785,786                         | 054 TMFR401K8     | METAL FILM RESISTOR 1/4W 1.8K      |
| R715-730                         | 054 TMFR4010R     | METAL FILM RESISTOR 1/4W 10        |
| R623,624,629,630                 | 054 TMFR4100R     | METAL FILM RESISTOR 1/4W 100       |
| R687-690,697,698                 | 054 TMFR4100K     | METAL FILM RESISTOR 1/4W 100K      |
| R701,702,705,706                 | 054 TMFR4100K     | METAL FILM RESISTOR 1/4W 100K      |
| R505-508,711,712,(R905)          | 054 TMFR4010K     | METAL FILM RESISTOR 1/4W 10K       |
| R703,704                         | 054 TMFR4120K     | METAL FILM RESISTOR 1/4W 120K      |
| R621,622,643,644,733,734         | 054 TMFR4150K     | METAL FILM RESISTOR 1/4W 150K      |
| R775,776                         | 054 TMFR4015K     | METAL FILM RESISTOR 1/4W 15K       |
| R509,510,631,632,731,732,R766    | 054 TMFR4001K     | METAL FILM RESISTOR 1/4W 1K        |
| R691,692                         | 054 TMFR4001M     | METAL FILM RESISTOR 1/4W 1M        |
| R611,612,619,620,667-670         | 054 TMFR4220R     | METAL FILM RESISTOR 1/4W 220       |
| R501-504,699,700,707,708         | 054 TMFR4022K     | METAL FILM RESISTOR 1/4W 22K       |
| R627,628                         | 054 TMFR403K9     | METAL FILM RESISTOR 1/4W 3.9K      |
| R773,774                         | 054 TMFR4033K     | METAL FILM RESISTOR 1/4W 33K       |
| R787,788                         | 054 TMFR404K7     | METAL FILM RESISTOR 1/4W 4.7K      |
| R633,634                         | 054 TMFR4047R     | METAL FILM RESISTOR 1/4W 47        |
| R671-686,693-696,781-784         | 054 TMFR4047K     | METAL FILM RESISTOR 1/4W 47K       |

## Parts List 2/3

| SYMBOL   | PARTS NO.         | DESCRIPTION                            |
|--|-------------------|--|
| R771,772,779,780,613,614                       | 054 TMFR4560R     | METAL FILM RESISTOR 1/4W 560           |
| R657,658                                       | 054 TMFR4056K     | METAL FILM RESISTOR 1/4W 56K           |
| R713,714,625,626                               | 054 TMFR406K8     | METAL FILM RESISTOR 1/4W 6.8K          |
| (R905)   | 054 TMFR406K8     | METAL FILM RESISTOR 1/4W 6.8K          |
| R709,710                                       | 054 TMFR4068K     | METAL FILM RESISTOR 1/4W 68K           |
| R663,664                                       | 054 1WS10JF       | METAL OXIDE FILM RESISTOR 1W 10        |
| R789,790                                       | 054 1WS330JF      | METAL OXIDE FILM RESISTOR 1W 330       |
| R655,656                                       | 054 3WS10JF       | METAL OXIDE FILM RESISTOR 3W 10        |
| R659-662                                       | 054 3WS6.8KJF     | METAL OXIDE FILM RESISTOR 3W 6.8K      |
| R763-765,767-770                               | 054 MF16-1001-A   | MOF RESISTOR 1/6W 1K                   |
| R751-758                                       | 054 MF16-22R0-A   | MOF RESISTOR 1/6W 22                   |
| R759-762                                       | 054 MF16-6801-A   | MOF RESISTOR 1/6W 6.8K                 |
| R665,666                                       | 054 TMF3300       | MOF RESISTOR 330                       |
| R635-642,645-652                               | 054 MPC74-0.22F   | RESISTOR PLATE 5W 0.22                 |
| R653,654                                       | 054 MPC71-1F      | RESISTOR PLATE 5W 1                    |
| R601,602                                       | 054 TRC55Z1501F   | RESISTOR RC55Z 1.5K                    |
| R603,604                                       | 054 TRC55Z3302F   | RESISTOR RC55Z 33K                     |
| R613,R614                                      | 054 TRC55Z5600F   | RESISTOR RC55Z 560                     |
| S901   | 061 C-4176A07     | POWER SWITCH PS3-22-L3AV TV-8 (4P PCB) |
| RY601,602                                      | 063 DE2TU-24      | RELAY DE24D2-OT(M)                     |
| S401   | 064 C-4613A01     | TOGGLE SWITCH 200DP1T2B2M7RE           |
| DJ1,DJ2  | 066 C-4575A01     | 3P CANON JACK (FEMALE) YKF52-5006      |
| CON1,CON2                                      | 068 C-3683#2      | PCB TERMINAL 3P P7.5 TP WE-12 I-753NA  |
| N1,N2,P1,P2,OUT1,OUT2                          | 069 C-4446A00     | PCB TERMINAL Y-105                     |
| <b>016 X-1291_01-02 PCB ASSY</b>               |                   |  |
|  | 501 X-1291E       | PCB ASSY                               |
| T101   | 022 T-1075N02     | SUB TRANSFORMER (with 016 X1291E)      |
| D101   | 034 W02M          | POWER DIODE 1.5A 200V                  |
| F101   | 036 5ST500        | FUSE 250VT500MA                        |
| F903   | 036 R251-250      | FUSE F250MA                            |
| C101   | 041 TUTES1E471-TS | ELECTROLYTIC CAPACITOR 25V470uF        |
| R106   | 054 1WS120JF      | MOF RESISTOR 1W 120                    |
| K104   | 068 C-3681#1      | WRAPPING TERMINAL 2P                   |
| AC1.AC5  | 068 C-4422A01     | WRAPPING TERMINAL 2P                   |
| <b>016 E-1328A00 PCB ASSY (Surge Absorber)</b> |                   |  |
|  | 501 E-1328A       | PCB ASSY                               |
| TH902  | 034 SCK2R512      | SURGE CURRENT THERMISTOR 5Ω            |
| D910   | 034 TIN4148-86    | DIODE 1N4148TAP-50                     |
| C920   | 044 DE1307E472M   | SPARK KILLER 4700pF                    |
| R901   | 054 RWH20G10RJ    | RESISTOR 20W 10 (for 230V VERSION)     |
| R901   | 054 RWH20G5RJ     | RESISTOR 20W 5 (for 115V VERSION)      |
| RY901  | 063 OZT-SS-112LM1 | RELAY DC 12V TV8 OZT-SS-112LM1         |
| TH901  | 063 UI300B        | THERMOSTAT UI-2                        |
| TM1,TM4,TM5,TM6                                | 068 C-3683#1      | PCB TERMINAL 2P P7.5 TP WE-11 I-752NA  |
| TM2,TM3  | 068 C-3683#3      | WRAPPING PIN TERMINAL 4P               |
| ACN,ACL  | 069 C-4370A00     | PCB TERMINAL Y-102                     |
| <b>016 X-1348A00 PCB ASSY (Delay)</b>          |                   |  |
|  | 501 X-1348-A      | PCB ASSY                               |
| T11  | 032 TA608-FG      | TRANSISTOR 2SA608KAA-FG                |
| T12  | 032 TC536-FG      | TRANSISTOR 2SC536KAA-F                 |
| D11  | 034 TRD4.7JST1    | ZENER DIODE 4.7V (AB2)                 |
| C11  | 041 TUTES1H100-TF | ELECTROLYTIC CAPACITOR 50V10uF         |
| R11,12,14                                      | 053 CR14-103J-A   | CARBON RESISTOR 1/4W 10K               |
| R13  | 053 CR14-334J-A   | CARBON RESISTOR 1/4W 330K              |
| K13  | 068 C-3681#3      | WRAPPING TERMINAL 4P                   |
| <b>HEAT SINKER ASSEMBLY</b>                    |                   |  |
| Q617,618                                       | 032 D1953         | TRANSISTOR 2SD1953                     |
| Q633,634                                       | 033 A1294-OY      | TRANSISTOR 2SA1294-OY                  |
| Q623-630                                       | 033 A1295-OY      | TRANSISTOR 2SA1295-OY                  |

## Parts List 3/3

| SYMBOL    | PARTS NO.        | DESCRIPTION                        |
|-----------|------------------|------------------------------------|
| Q635,636  | 033 C3263-OY     | TRANSISTOR 2SC3263-OY              |
| Q637-644  | 033 C3264-OY     | TRANSISTOR 2SC3264-OY              |
|           | 019 TO-3P        | INSULATION SHEET(S)                |
|           | 019 TO-3P2       | INSULATION SHEET(L)                |
|           | <b>OTHERS</b>    |                                    |
|           | 011 FP-499A-B    | BLACK PANEL ASSY                   |
|           | 011 FP-499A-S    | SILVER PANEL ASSY                  |
|           | 011 SG4-02C00    | H/S PANEL                          |
|           | 012 RV4-09A00    | PUSH BUTTON 14F (BLACK)            |
|           | 012 RV4-09A01    | PUSH BUTTON 14F (SILVER)           |
|           | 013 SG4-05A00    | SUB PANEL SUPPORT(BLACK) .         |
|           | 013 SG4-05A01    | SUB PANEL SUPPORT(SILVER) .        |
|           | 014 SG3-18A00    | UPPER COVER                        |
|           | 015 RP-354C      | REAR CHASSIS                       |
|           | 019 C-4638A00    | CASTER 32Φ                         |
|           | 019 C-670#18     | FELT 56Φ (for FOOT)                |
|           | 019 C-4418A00    | PLASTIC FOOT 26Φ                   |
|           | 019 PK4-07A00T   | METAL FOOT 60Φ                     |
| T001      | 022 T-1061U01    | POWER TRANSFORMER                  |
| T002      | 022 T-1064U01    | POWER TRANSFORMER                  |
| D004,D005 | 034 BR254        | POWER SIODE 25A 400V               |
|           | 034 LTL1214A     | LED (RED) 2Φ                       |
|           | 034 SEL1124R     | LED (RED) 1X5                      |
|           | 034 SEL1E24W     | LED (BLU) 1X5                      |
|           | 036 5ST10        | FUSE 250V10A                       |
| C001-C008 | 041 ALS30S1072MF | ELECTROLYTIC CAPACITOR 100V22000uF |
| SP2A,SP2B | 067 C-4717A02    | SPEAKER TERMINAL (BLACK)           |
| SP2A,SP2B | 067 C-4717A01    | SPEAKER TERMINAL (RED))            |
|           | 069 C-4637A00    | AC INLET(3P) 0707-1-CW             |
|           | 072 C-4392A04    | AC CORD SET (SJT AWG14) for USA    |
|           | 072 C-4393A03    | AC CORD SET for EUROPE             |
|           | 072 C-4423A03    | AC CORD SET for AUSTRALIA          |
|           | 072 C-4639A01    | AC CORD SET for U.K.               |
|           | 081 SG3-22B01    | INSIDE CARTON -V01                 |
|           | 081 SG3-23B01    | SHIPPING CARTON -V01               |
|           | 081 SG4-24A00    | PACKING (for INSIDE CARTON)        |
|           | 081 Z-200        | STYROL MOULDING                    |
|           | 082 OMRB-1090-1  | OWNER'S MANUAL(EFGISD)             |

# Addendum List for Black and Silver

RB1090

| SYMBOL | PARTS         | DESCRIPTION             |
|--------|---------------|-------------------------|
| ①      | 011 FP-499A-B | BLACK PANEL ASSY        |
| ②      | 011 FP-499A-S | SILVER PANEL ASSY       |
| ③      | 011 SG4-02C00 | H/S PANEL H221          |
|        | 012 RV4-09A00 | PUSH BUTTON 14F (BLK)   |
|        | 012 RV4-09A01 | PUSH BUTTON 14F (SLV)   |
| ④      | 013 SG4-05A00 | SUB PANEL CHASSIS (BLK) |
| ⑤      | 013 SG4-05A01 | SUB PANEL CHASSIS (SLV) |
|        | 034 SEL1124R  | LED (RED) 1X5           |
|        | 034 SEL1E24W  | LED (BLU) 1X5           |

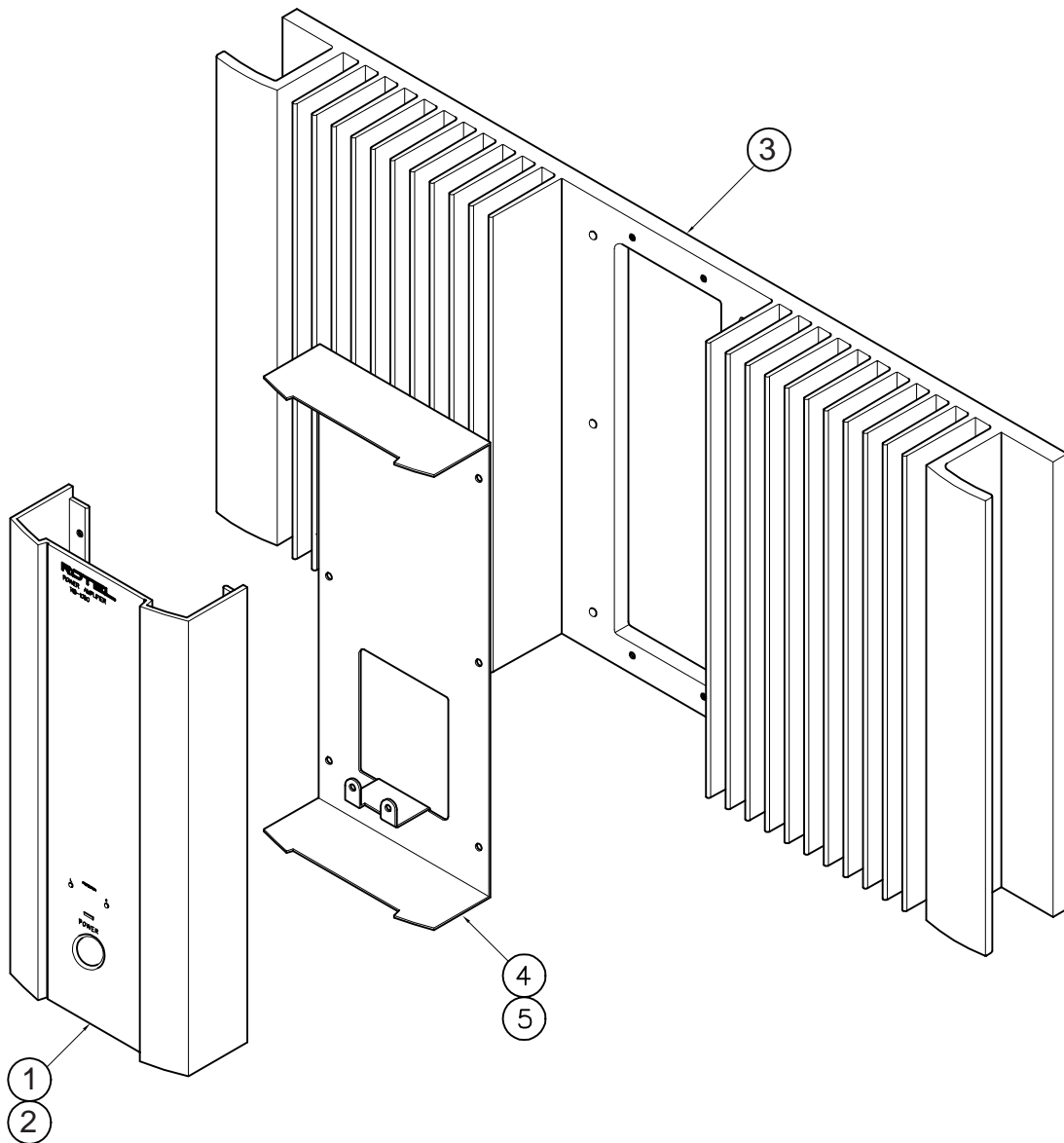

# Adjustment

RB-1090

Instruments : DC milli-voltmeter

Notes : Prior to Bias Adjustment, run about 5minutes with rated output(8ohms) and warm up Power Transistor and Heat Sink. Set input off.

| Step | Coupling | Location      | Adjust | Adjust for                   |
|------|----------|---------------|--------|------------------------------|
| 1    | L CH OUT | X-1271-01 PCB | VR603  | DC milli-voltmeter reads 0mV |
| 2    | R CH OUT | X-1271-02 PCB | VR604  |                              |
| 3    | TP1      | X-1271-01 PCB | VR601  | DC milli-voltmeter reads 5mV |
| 4    | TP2      | X-1271-02 PCB | VR602  |                              |

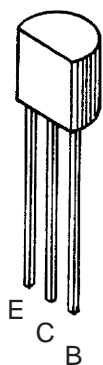

2SA1016K  
2SC2362K

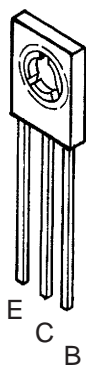

2SB631K  
2SD600K  
2SA1209  
2SC2911  
2SD1953

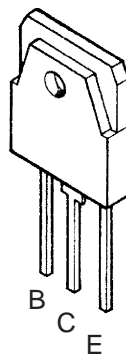

2SA1294  
2SC3263

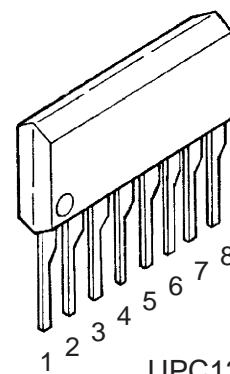

UPC1237HA

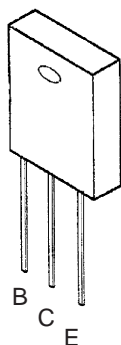

2SC5174  
2SA1932

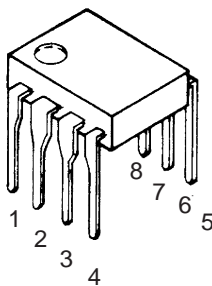

AD711JN  
OPA134PA

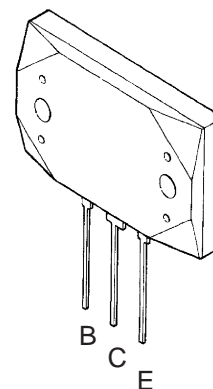

2SA1295  
2SC3264

# Memo





