



Your Work Never Looked Better





Spectrum Series



4V/4Vlr
4VA/4VlrA

USER MANUAL

TABLE OF CONTENTS

	ENGLISH	
FOR YOUR SAFETY -----	1	
SAFETY PRECAUTIONS -----	2	DEUTSCH 
BEFORE YOU OPERATE THE MONITOR -----	3	
FEATURES -----	3	
PACKING LIST -----	3	FRANCAIS 
INSTALLATION INSTRUCTIONS -----	3	
CONTROLS AND CONNECTORS -----	4	
OPERATING INSTRUCTIONS -----	5	ESPAÑOL 
GENERAL INSTRUCTIONS -----	5	
HOW TO ADJUST A SETTING -----	6	
ADJUSTING THE PICTURE -----	7	ITALIANO 
POWER MANAGEMENT FEATURE -----	7	
PLUG AND PLAY -----	9	
TECHNICAL SUPPORT(FAQ) -----	10	
APPENDIX -----	11	
SPECIFICATIONS -----	11-12	
FACTORY PRESET TIMING TABLE -----	13	
CONNECTOR PIN ASSIGNMENT -----	13	
LIMITED THREE-YEAR WARRANTY -----	14-15	



Thank you very much for choosing the AOC Color Monitor.

We recommend that you take a few minutes to read carefully through this brief but comprehensive manual before installing and switching on the

**Plug & Play Drivers for the AOC Spectrum Series Monitors are available
at AOC' s Web Site: www.aoc-europe.com**

WARNING: (FOR FCC CERTIFIED MODELS)

NOTE: This equipment has been tested and found to comply with the limits for a Class B digital device, pursuant to Part 15 of the FCC Rules. These limits are designed to provide reasonable protection against harmful interference in a residential installation. This equipment generates, uses and can radiate radio frequency energy, and if not installed and used in accordance with the instructions, may cause harmful interference to radio communications. However, there is no guarantee that interference will not occur in a particular installation. If this equipment does cause harmful interference to radio or television reception, which can be determined by turning the equipment off and on, the user is encouraged to try to correct the interference by one or more of the following measures:

1. Reorient or relocate the receiving antenna.
2. Increase the separation between the equipment and receiver.
3. Connect the equipment into an outlet on a circuit different from that to which the receiver is connected.
4. Consult the dealer or an experienced radio/TV technician for help.

NOTICE :

1. The changes or modifications not expressly approved by the party responsible for compliance could void the user's authority to operate the equipment.
2. Shielded interface cables and AC power cord, if any, must be used in order to comply with the emission limits.
3. The manufacturer is not responsible for any radio or TV interference caused by unauthorized modification to this equipment. It is the responsibilities of the user to correct such interference.

As an ENERGY STAR® Partner AOC International has determined that this product meets the ENERGY STAR® guidelines for energy efficiency.

WARNING :

To prevent fire or shock hazard, do not expose the monitor to rain or moisture. Dangerously high voltages are present inside the monitor. Do not open the cabinet. Refer servicing to qualified personnel only.

PRECAUTIONS

- Do not use the monitor near water, e.g. near a bathtub, washbowl, kitchen sink, laundry tub, swimming pool or in a wet basement.
- Do not place the monitor on an unstable cart, stand, or table. If the monitor falls, it can injure a person and cause serious damage to the appliance. Use only a cart or stand recommended by the manufacturer or sold with the monitor. If you mount the monitor on a wall or shelf, use a mounting kit approved by the manufacturer and follow the kit instructions.
- Slots and openings in the back and bottom of the cabinet are provided for ventilation. To ensure reliable operation of the monitor and to protect it from overheating, be sure these openings are not blocked or covered. Do not place the monitor on a bed, sofa, rug, or similar surface. Do not place the monitor near or over a radiator or heat register. Do not place the monitor in a bookcase or cabinet unless proper ventilation is provided.
- The monitor should be operated only from the type of power source indicated on the label. If you are not sure of the type of power supplied to your home, consult your dealer or local power company.
- The monitor is equipped with a three-pronged grounded plug, a plug with a third (grounding) pin. This plug will fit only into a grounded power outlet as a safety feature. If your outlet does not accommodate the three-wire plug, have an electrician install the correct outlet, or use an adapter to ground the appliance safely. Do not defeat the safety purpose of the grounded plug.
- Unplug the unit during a lightning storm or when it will not be used for long periods of time. This will protect the monitor from damage due to power surges.
- Do not overload power strips and extension cords. Overloading can result in fire or electric shock.
- Never push any object into the slot on the monitor cabinet. It could short circuit parts causing a fire or electric shock. Never spill liquids on the monitor.
- Do not attempt to service the monitor yourself; opening or removing covers can expose you to dangerous voltages and other hazards. Please refer all servicing to qualified service personnel.
- To ensure satisfactory operation, use the monitor only with UL listed computers which have appropriate configured receptacles marked between 100 - 240V AC, Min. 1.5A.

BEFORE YOU OPERATE THE MONITOR

FEATURES

- 35.5cm(14") Color Monitor
- Crisp, Clear Display for Windows
- Supports Resolutions up to 1024 x 768
- Power Management
- Ergonomic Design (MPR II Approved for 4Vlr/4VlrA)
- Space Saving, Compact Case Design

CHECKING THE CONTENTS OF THE MONITOR PACKAGE

The product package should include the following items:

1. Monitor
2. Owner's Manual
3. Power Cord (Refer to the "Using the right power cord" statement)
4. Swivel Base
5. Audio Cable (For 4VA/4VlrA only)

INSTALLATION INSTRUCTIONS

SWIVEL BASE

To attach the swivel base to the monitor, do the following:

- Carefully turn the monitor on its side or upside down. (see figure 1)
- Locate the cavities at the bottom front of the monitor.
- Insert the pegs on the swivel base into these cavities. Push the swivel base forward until the swivel base locks in place.
- To remove the swivel base, hold the bottom of the swivel base, then push it out.

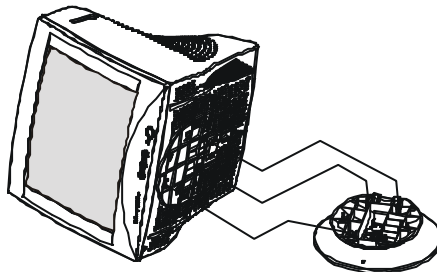

Figure 1 Installing and Removing the Swivel Base

POWER CORD

Power Source:

1. Make sure the power cord is the correct type that required in your area.
2. This monitor has a universal power supply that allows operation in either 100/120V AC or 220/240V AC voltage area (No user adjustment is required.)
3. Connect the power cord into your monitor' s power input socket, and then plug the other end into a 3-pin AC power outlet. The power cord may be connected to either a wall power outlet or the power outlet socket on your PC, depending on the type of power cord supplied with your monitor.

CONTROLS AND CONNECTORS

VIDEO CABLE

Connecting the Video Cable: the monitor comes with a built-in video cable. Plug the signal cable's 15-pin connector into the computer's video port and tighten the two screws on the cable connector. (see figure 2)

Caution: *Don' t bend the signal cable, otherwise it will break the inner wire.*

Connecting the Power Cord: Plug the power cord into the monitor's AC power jack. Then plug the power cord into a grounded AC outlet, UL-approved power strip, or the power output socket on your PC.

Caution: *If the AC outlet is not grounded, install the proper grounding adapter (not supplied).*

Connecting the Earphone Cable (4VA/4VlrA only): Plug earphone cable into earphone output jack.

Connecting the Audio Cable (4VA/4VlrA only): Plug one end of the audio cable into the computer' s multi-media (or sound) card's audio output and the other end into the monitor's audio input.

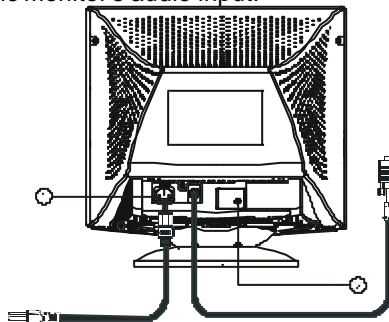

Figure 2 Connecting Cables

1. AC Inlet

2.	Earphone (4VA/4VlrA only)
3.	Audio In (4VA/4VlrA only)

OPERATING INSTRUCTIONS

GENERAL INSTRUCTIONS

The power switch is located at front panel of the monitor. Press the power switch to turn the monitor on or off. The other control knobs are located at the base of the monitor (See Figure 3). By changing these settings, the picture can be adjusted to your personal preferences.

- The power cord should be connected.
- Connect the video cable from the monitor to the video card.
- To turn the monitor on, press the POWER switch to ON position. The power indicator will light up.
- Your monitor features a unique quick switch system which provides a picture within seconds after the monitor is switched on.

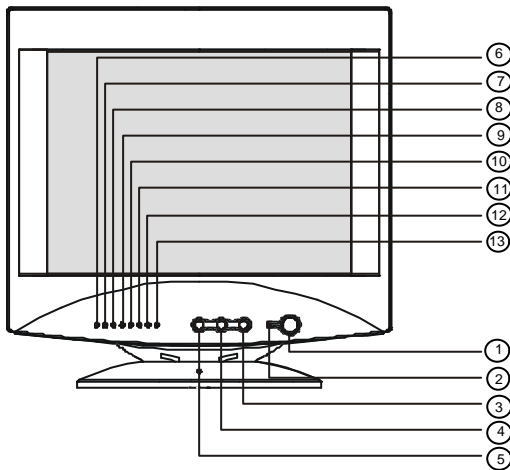

Figure 3 External Control Knob



EXTERNAL CONTROLS

Switch:		Functions:	
1.	Power On/Off Switch	6.	Contrast
2.	LED	7.	Brightness
3.	Up Key	8.	H-Size
4.	Down Key	9.	H-Center
5.	Function Key	10.	V-Size
		11.	V-Center
		12.	Pincushion
		13.	Trapezoid

NOTES









- Do not install the monitor in a location near heat sources such as radiators or air ducts , or in a place subject to direct sunlight , or excessive dust or mechanical vibration or shock.
- Save the original shipping carton and packing materials, as they will come in handy if you ever have to ship your monitor.
- For maximum protection, repackage your monitor as it was originally packed at the factory.
- To keep the monitor looking new, periodically clean it with a soft cloth. Stubborn stains may be removed with a cloth lightly dampened with a mild detergent solution. Never use strong solvents such as thinner, benzene, or abrasive cleaners, since these will damage the cabinet. As a safety precaution, always unplug the monitor before cleaning it.

HOW TO ADJUST A SETTING

1. Press the knob, the green LED lights and the power is ON.
Press this knob again, the green LED disappears and the power is OFF.
2. When press the “FUNC” key, the LED will flash to indicate the function has been selected.
3. When function has been selected, press  or  to adjust picture image.
4. Press the Up or Down key to get the optimal volume for the multimedia model only. The most left LED will flash to indicate the adjustable levels have reached to the maximum or minimum.
5. If you press the Func. & Down keys simultaneously it functions as an audio mute, and press Up or Down key to release audio function for multimedia model only.

ADJUSTING THE PICTURE

The description for function control LEDs

1.		CONTRAST	Adjust the picture contrast.
2.		BRIGHTNESS	Adjust the picture brightness.
3.		H-SIZE	Adjust the picture's horizontal size.
4.		H-CENTER	Adjust the horizontal position of the picture.
5.		V-SIZE	Adjust the picture's vertical size.
6.		V-CENTER	Adjust the vertical position of the picture.
7.		PINCUSHION	Adjust the pincushion and barrel.
8.		TRAPEZOID	Adjust the picture's trapezoid distortion.
9.		RECALL	To recall original factory preset mode.

POWER MANAGEMENT FEATURE

The power management feature of this product complies with every power saving requirements of ENERGY STAR® and VESA DPMS when activated, it automatically reduces unnecessary power consumption of the monitor when your computer is not in use.

To use the feature, the monitor needs to be connected to a VESA DPMS computer. There are three power management modes available, these are described below. The required settings, including the timer setting, should be made by the computer.

• Stand-by Mode

When the H-sync signal from the computer is off, the monitor enters into Stand-by Mode which reduces the power consumption to less than 15W. The screen becomes dark, and the power indicator turns to orange. From Stand-by Mode, the screen reappears instantaneously when the keyboard or the mouse is touched again.

- **Suspend Mode**

When the V-sync signal from the computer is off, the monitor enters into Suspend Mode which reduces the power consumption to less than 15W. The screen becomes dark, and the power indicator turns to orange. From Suspend Mode, the screen reappears instantaneously when the keyboard or the mouse is touched again.

- **Active-off Mode**

When both the H and V sync signals from the computer are off, the monitor enters into Active-off Mode which reduces the power consumption to less than 8W. The screen becomes dark, and the power indicator turns to orange. From Active-off Mode, the screen reappears instantaneously when the keyboard or the mouse is touched again.

- The power-saving mode can be indicated by the light-emitting diode (LED) on the front panel:

Mode	Signal				Power	
	Cable	H-Sync	V-Sync	Video	Indicator	Consumption
On*	Attached	Yes	Yes	Active	Green	≤ 90 W
Stand-by	Attached	No	Yes	Blank	Orange	≤ 15 W
Suspend	Attached	Yes	No	Blank	Orange	≤ 15 W
Off	Attached	No	No	Blank	Orange	≤ 8 W

FEATURES

Green monitor

- The monitor has a power saving function that conforms to the VESA DPMS standard. This feature will only work if your PC is a green PC. This feature is similar to a screen saver, except that your monitor will turn it off instead of activating the screen saver.

To activate this feature in Windows[®] 98 :

In Windows[®] 98, this feature can be activated and customized under the screen saver setting of the display properties.

1. Right click on the desktop and choose Properties.
2. Click on the tab that says Screen Saver. If your system supports Green PC, there will be a section entitled "Energy Saving Features of Monitor." If there isn't a section like that, then your PC does not support Green Monitor. The monitor will behave just like a normal monitor, so you will have to turn it off manually to save energy.
3. In the "Energy Saving Features of Monitor" sections are two boxes, Standby and Shut off. To activate either one, click the box next to each one.
4. You can specify the amount of inactive time before your monitor enters standby mode or shuts off.

PLUG AND PLAY

Plug & Play DDC1/2B Feature

This monitor is equipped with VESA DDC1/2B capabilities according to the VESA DDC STANDARD. It allows the monitor to inform the host system of its identity and, depending on the level of DDC used, communicate additional information about its display capabilities. The communication channel is defined in two levels, DDC1 and DDC2B.

The DDC1 is a unidirectional data channel from the display to the host that continuously transmits EDID information. The DDC2B is a bidirectional data channel based on the I²C protocol. The host can request EDID information over the DDC2B channel.

THIS MONITOR WILL APPEAR TO BE NON-FUNCTIONAL IF THERE IS NO VIDEO INPUT SIGNAL. IN ORDER FOR THIS MONITOR TO OPERATE PROPERLY, THERE MUST BE A VIDEO INPUT SIGNAL.

This monitor meets the Power Management standards as set by the Video Electronics Standards Association (VESA) and/or the United States Environmental Protection Agency (EPA) and The Swedish Confederation Employees (NUTEK). This feature is designed to conserve electrical energy by reducing power consumption when there is no video input signal present. When there is no video input signal this monitor, following a time-out period, will automatically switch to an OFF mode. This reduces the monitor's internal power supply consumption. After the video input signal is restored, full power is restored and the display is automatically redrawn. The appearance is similar to a "Screen Saver" feature except the display is completely off. The display is restored by pressing a key on the keyboard, or clicking the mouse.

USING THE RIGHT POWER CORD :

The accessory power cord for the Northern American region is the wallet plug with NEMA 5-15 style and is UL listed and CSA labeled. The voltage rating for the power cord shall be 125 volts AC.

Supplied with units intended for connection to power outlet of personal computer: Please use a cord set consisting of a minimum No. 18 AWG, type SJT or SVT three conductors flexible cord. One end terminates with a grounding type attachment plug, rated 10A, 250V, CEE-22 male

configuration. The other end terminates with a molded-on type connector body, rated 10A, 250V, having standard CEE-22 female configuration.

TECHNICAL SUPPORT (FAQ)

Problem & Question	Possible Solution
Power LED is not on	<ul style="list-style-type: none"> *Check if the Power Switch is in the ON position *Power Cord should be connected
No Plug & Play	<ul style="list-style-type: none"> *Check if the PC System is Plug & Play compatible *Check if the Video Card is Plug & Play compatible *Check if the D-15 plug pin of Video Cable is bent *Make sure the AOC Monitor Drivers are installed (AOC Monitor Drivers are available at: www.aoc-europe.com)
No picture	<ul style="list-style-type: none"> *Computer Power Switch should be in the ON position *Computer Video Card should be snugly seated in its slot *The Signal Cable should be completely connected to the computer *Check the color of the Power LED indicator. If it is orange, then the monitor and the PC system are in power-saving mode. You need press your keyboard or move the mouse to reactivate the system.
Picture is fuzzy	<ul style="list-style-type: none"> *Adjust the Contrast and Brightness Controls.
Picture bounces or a wave pattern is present in the picture	<ul style="list-style-type: none"> *Move electrical devices that may cause electrical interference.
Monitor is stuck in "Power Saving Mode"	<ul style="list-style-type: none"> *Make sure monitor's video cable is properly connected to the computer. *Inspect monitor's video cable and make sure none of the pins are bent. *Make sure computer is operational by hitting the CAPS LOCK key on the keyboard while observing the CAPS LOCK LED. The LED should either turn ON or OFF after hitting the CAPS LOCK key.
Missing one of the primary colors (RED, GREEN, or	<ul style="list-style-type: none"> *Inspect the monitor's video cable and make sure that none of the pins are

BLUE)

bent.

APPENDIX

SPECIFICATIONS

CRT	CRT Size	35.5cm(14"), 90° deflection, 29mm neck
	Viewable Image Size	33.5cm (13.2"), diagonal
	Type	0.28mm dot pitch
Input	Video	0.7Vpp, R,G,B Analog
	Separate Sync.	TTL Level
	H.V. - Sync.	Positive / Negative
Scanning Frequency	H-Frequency	30kHz - 54kHz
	V-Frequency	50Hz-120Hz
Max. Resolution		1024 x 768
Video Dot Rate		65MHz
Factory Preset mode :		5
User Programmable mode :		12
Power Source		Universal AC 100 - 240V, 50Hz / 60Hz
Operating		0° C to 40° C ambient
Humidity		10%to 85%relative, non-condensing
Dimensions	Monitor & Base Unit(net)	350(W) × 349(H) × 377(D)mm
Weight		10.5kgs(net)
Signal Cable:		Attached Mini D-sub 15 Male

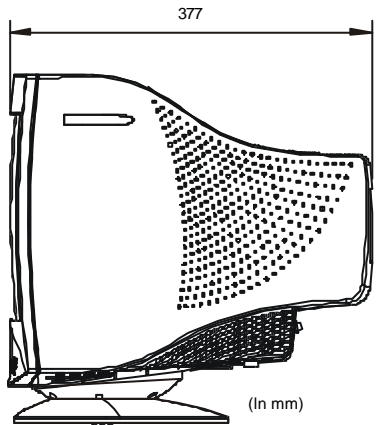
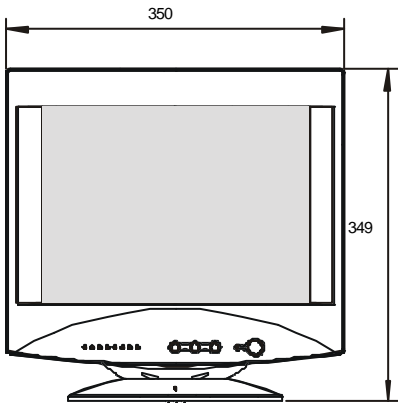

External Controls:	Switch	<ul style="list-style-type: none"> • Power On/Off switch • Up/Down Key • Function Key
	Functions	<ul style="list-style-type: none"> • Contrast • Brightness • H-Size • H-Center • V-Size • V-Center • Pincushion • Trapezoid • Volume (for 4VA/4VlrA only)
Plug & Play		DDC1/2B
Power Management		EPA, VESA DPMS
Power Consumption (Maximum)		90 Watts
Pre-set Display Area		250mm x 187mm
Audio Output (for 4VA/4VlrA only)		Rated Power 1W rms
Regulatory Compliance		UL, CSA, FDA, FCC, TÜV/GS, CE, MPR II (for 4Vlr/4VlrA only)

FACTORY PRESET TIMING TABLE

STANDARD	RESOLUTION	HORIZONTAL FREQUENCY	VERTICAL FREQUENCY
IBM	720 x 400	31.47kHz	70Hz
VGA	640 x 480	31.47kHz	60Hz
VESA/85	640 x 480	43.3kHz	85Hz
VESA/85	800 x 600	53.67kHz	85Hz
VESA/60	1024 x 768	48.36kHz	60Hz

CONNECTOR PIN ASSIGNMENT

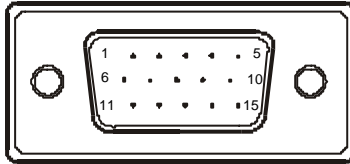

15 - Pin Color Display Signal Cable

PIN NO.	DESCRIPTION	PIN NO.	DESCRIPTION
1.	Red	9.	NC
2.	Green	10.	Ground
3.	Blue	11.	Monitor Ground
4.	Ground	12.	DDC-Serial Data
5.	Ground	13.	H-Sync
6.	R-Ground	14.	V-Sync / *V-Clk
7.	G-Ground	15.	DDC-Serial Clock
8.	B-Ground	*	For DDC

LIMITED THREE-YEAR WARRANTY*

for

AOC Spectrum Color Monitors sold within Europe

AOC International (Europe) GmbH warrants this product to be free from defects in material and workmanship for a period of Three (3) years after the original date of consumer purchase. During this period, AOC International (Europe) GmbH will, at its option, either repair the defective product with new or rebuilt parts, or replace it with a new or rebuilt product at no charge except as *stated below. The defective products that are replaced become the property of AOC International (Europe) GmbH.

If the product appears to be defective, please contact your local dealer or refer to the warranty card when attached to the product.

Deliver the product freight pre-paid, along with the dated proof of purchase, to the AOC Authorized Service Center. If you cannot deliver the product in person:

- Pack it in its original shipping container (or equivalent)
- Put the RMA number on the address label
- Put the RMA number on the shipping carton
- Insure it (or assume the risk of loss/damage during shipment)
- Pay all shipping charges

AOC International (Europe) GmbH is responsible neither for any damage or loss during inbound transport damage nor to inbound product that was not properly packaged.

AOC International (Europe) GmbH will pay the return shipping charges within one of the countries specified within this warranty statement.

AOC International (Europe) GmbH is not responsible for any costs associated with the transportation of product across international borders. This includes the international border within the European Union.

* This limited warranty does not cover any losses or damages that occur as a result of

- Shipping or improper installation or maintenance
- Misuse
- Neglect
- Any cause other than ordinary commercial or industrial application
- Adjustment by non-authorized source
- Repair, modification, or installation of options or parts by anyone other than an AOC Authorized Service Center
- Improper environment
- Excessive or inadequate heating or air conditioning or electrical powers failures, surges, or other irregularities

This limited warranty does not cover any of the product firmware or hardware that you or any third party have modified or altered; you bear the sole responsibility and liability for any such modification or alteration.

ALL EXPRESS AND IMPLIED WARRANTIES FOR THIS PRODUCT (INCLUDING THE WARRANTIES OF MERCHANTABILITY AND FITNESS FOR A PARTICULAR PURPOSE) ARE LIMITED IN DURATION TO A PERIOD OF THREE (3) YEARS FOR PARTS AND LABOR FROM THE ORIGINAL DATE OF CONSUMER PURCHASE. NO WARRANTIES (EITHER EXPRESSED OR IMPLIED) APPLY AFTER THIS PERIOD.

AOC INTERNATIONAL (EUROPE) GMBH OBLIGATIONS AND YOUR REMEDIES HEREUNDER ARE SOLELY AND EXCLUSIVELY AS STATED HERE. AOC INTERNATIONAL (EUROPE) GMBH LIABILITY, WHETHER BASED ON CONTRACT, TORT, WARRANTY, STRICT LIABILITY, OR OTHER THEORY, SHALL NOT EXCEED THE PRICE OF THE INDIVIDUAL UNIT WHOSE DEFECT OR DAMAGE IS THE BASIS OF THE CLAIM. IN NO EVENT SHALL AOC INTERNATIONAL (EUROPE) GMBH BE LIABLE FOR ANY LOSS OF PROFITS, LOSS OF USE OR FACILITIES OR EQUIPMENT, OR OTHER INDIRECT, INCIDENTAL, OR CONSEQUENTIAL DAMAGE. SOME STATES DO NOT ALLOW THE EXCLUSION OR LIMITATION OF INCIDENTAL OR CONSEQUENTIAL DAMAGES, SO THE ABOVE LIMITATION MAY NOT APPLY TO YOU. ALTHOUGH THIS LIMITED WARRANTY GIVES YOU SPECIFIC LEGAL RIGHTS, YOU MAY HAVE OTHER RIGHTS, WHICH MAY VARY FROM COUNTRY TO COUNTRY. THIS LIMITED WARRANTY IS ONLY VALID FOR PRODUCTS PURCHASED IN THE MEMBER COUNTRIES OF THE EUROPEAN UNION.



Your Work Never Looked Better





Spectrum Series



5E/5EIr
5EA/5EIrA

USER MANUAL

TABLE OF CONTENTS

FOR YOUR SAFETY -----	1	ENGLISH	
SAFETY PRECAUTIONS -----	2		
BEFORE YOU OPERATE THE MONITOR -----	3	DEUTSCH	
FEATURES -----	3		
PACKING LIST -----	3	FRANÇAIS	
INSTALLATION INSTRUCTIONS -----	3		
CONTROLS AND CONNECTORS -----	4		
OPERATING INSTRUCTIONS -----	5	ESPAÑOL	
GENERAL INSTRUCTIONS -----	5		
HOW TO ADJUST A SETTING -----	6		
ADJUSTING THE PICTURE -----	7	ITALIANO	
POWER MANAGEMENT FEATURE -----	7		
PLUG AND PLAY -----	9		
TECHNICAL SUPPORT(FAQ) -----	10		
APPENDIX -----	11		
SPECIFICATIONS -----			
FACTORY PRESET TIMING TABLE -----	11-12		
CONNECTOR PIN ASSIGNMENT -----	13		
LIMITED THREE-YEAR WARRANTY -----	14-15		



Thank you very much for choosing the AOC Color Monitor.

We recommend that you take a few minutes to read carefully through this brief but comprehensive manual before installing and switching on the

Plug & Play Drivers for the AOC Spectrum Series Monitors are available at AOC's Web Site: www.aoc-europe.com

NOTE: This equipment has been tested and found to comply with the limits for a Class B digital device, pursuant to Part 15 of the FCC Rules. These limits are designed to provide reasonable protection against harmful interference in a residential installation. This equipment generates, uses and can radiate radio frequency energy, and if not installed and used in accordance with the instructions, may cause harmful interference to radio communications. However, there is no guarantee that interference will not occur in a particular installation. If this equipment does cause harmful interference to radio or television reception, which can be determined by turning the equipment off and on, the user is encouraged to try to correct the interference by one or more of the following measures:

1. Reorient or relocate the receiving antenna.
2. Increase the separation between the equipment and receiver.
3. Connect the equipment into an outlet on a circuit different from that to which the receiver is connected.
4. Consult the dealer or an experienced radio/TV technician for help.

NOTICE :

3. The changes or modifications not expressly approved by the party responsible for compliance could void the user's authority to operate the equipment.
4. Shielded interface cables and AC power cord, if any, must be used in order to comply with the emission limits.
6. The manufacturer is not responsible for any radio or TV interference caused by unauthorized modification to this equipment. It is the responsibilities of the user to correct such interference.

As an ENERGY STAR® Partner AOC International has determined that this product meets the ENERGY STAR® guidelines for energy efficiency.

WARNING :

To prevent fire or shock hazard, do not expose the monitor to rain or moisture. Dangerously high voltages are present inside the monitor. Do not open the cabinet. Refer servicing to qualified personnel only.

PRECAUTIONS

- Do not use the monitor near water, e.g. near a bathtub, washbowl, kitchen sink, laundry tub, swimming pool or in a wet basement.
- Do not place the monitor on an unstable cart, stand, or table. If the monitor falls, it can injure a person and cause serious damage to the appliance. Use only a cart or stand recommended by the manufacturer or sold with the monitor. If you mount the monitor on a wall or shelf, use a mounting kit approved by the manufacturer and follow the kit instructions.
- Slots and openings in the back and bottom of the cabinet are provided for ventilation. To ensure reliable operation of the monitor and to protect it from overheating, be sure these openings are not blocked or covered. Do not place the monitor on a bed, sofa, rug, or similar surface. Do not place the monitor near or over a radiator or heat register. Do not place the monitor in a bookcase or cabinet unless proper ventilation is provided.
- The monitor should be operated only from the type of power source indicated on the label. If you are not sure of the type of power supplied to your home, consult your dealer or local power company.
- The monitor is equipped with a three-pronged grounded plug, a plug with a third (grounding) pin. This plug will fit only into a grounded power outlet as a safety feature. If your outlet does not accommodate the three-wire plug, have an electrician install the correct outlet, or use an adapter to ground the appliance safely. Do not defeat the safety purpose of the grounded plug.
- Unplug the unit during a lightning storm or when it will not be used for long periods of time. This will protect the monitor from damage due to power surges.
- Do not overload power strips and extension cords. Overloading can result in fire or electric shock.
- Never push any object into the slot on the monitor cabinet. It could short circuit parts causing a fire or electric shock. Never spill liquids on the monitor.
- Do not attempt to service the monitor yourself; opening or removing covers can expose you to dangerous voltages and other hazards. Please refer all servicing to qualified service personnel.
- To ensure satisfactory operation, use the monitor only with UL listed computers which have appropriate configured receptacles marked between 100 - 240V AC, Min. 1.5A.

BEFORE YOU OPERATE THE MONITOR

FEATURES

- 38.1cm(15") Color Monitor
- Crisp, Clear Display for Windows
- Supports Resolutions up to 1024 x 768
- Power Management
- Ergonomic Design (MPR II Approved for 5Elr/5ElrA)
- Space Saving, Compact Case Design

CHECKING THE CONTENTS OF THE MONITOR PACKAGE

The product package should include the following items:

3. Monitor
4. Owner's Manual
4. Power Cord (Refer to the "Using the right power cord" statement)
7. Swivel Base
8. Audio Cable (For 5EA/5ElrA only)

INSTALLATION INSTRUCTIONS

SWIVEL BASE

To attach the swivel base to the monitor, do the following:

- Carefully turn the monitor on its side or upside down. (see figure 1)
- Locate the cavities at the bottom front of the monitor.
- Insert the pegs on the swivel base into these cavities. Push the swivel base forward until the swivel base locks in place.
- To remove the swivel base, hold the bottom of the swivel base, then push it out.

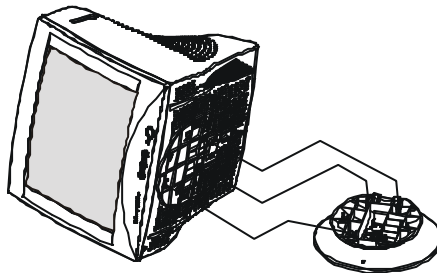

Figure 1 Installing and Removing the Swivel Base

POWER CORD

Power Source:

4. Make sure the power cord is the correct type that required in your area.
5. This monitor has a universal power supply that allows operation in either 100/120V AC or 220/240V AC voltage area (No user adjustment is required.)
6. Connect the power cord into your monitor' s power input socket, and then plug the other end into a 3-pin AC power outlet. The power cord may be connected to either a wall power outlet or the power outlet socket on your PC, depending on the type of power cord supplied with your monitor.

CONTROLS AND CONNECTORS

VIDEO CABLE

Connecting the Video Cable: the monitor comes with a built-in video cable. Plug the signal cable's 15-pin connector into the computer's video port and tighten the two screws on the cable connector. (see figure 2)

Caution: *Don' t bend the signal cable, otherwise it will break the inner wire.*

Connecting the Power Cord: Plug the power cord into the monitor's AC power jack. Then plug the power cord into a grounded AC outlet, UL-approved power strip, or the power output socket on your PC.

Caution: *If the AC outlet is not grounded, install the proper grounding adapter (not supplied).*

Connecting the Earphone Cable (5EA/5ElrA only): Plug earphone cable into earphone output jack.

Connecting the Audio Cable (5EA/5ElrA only): Plug one end of the audio cable into the computer' s multi-media (or sound) card's audio output and the other end into the monitor's audio input.

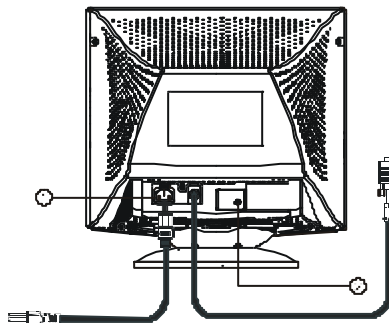

Figure 2 Connecting Cables

1. AC Inlet

2.	Earphone (5EA/5ElrA only)
3.	Audio In (5EA/5ElrA only)

OPERATING INSTRUCTIONS

GENERAL INSTRUCTIONS

The power switch is located at front panel of the monitor. Press the power switch to turn the monitor on or off. The other control knobs are located at the base of the monitor (See Figure 3). By changing these settings, the picture can be adjusted to your personal preferences.

- The power cord should be connected.
- Connect the video cable from the monitor to the video card.
- To turn the monitor on, press the POWER switch to ON position. The power indicator will light up.
- Your monitor features a unique quick switch system which provides a picture within seconds after the monitor is switched on.

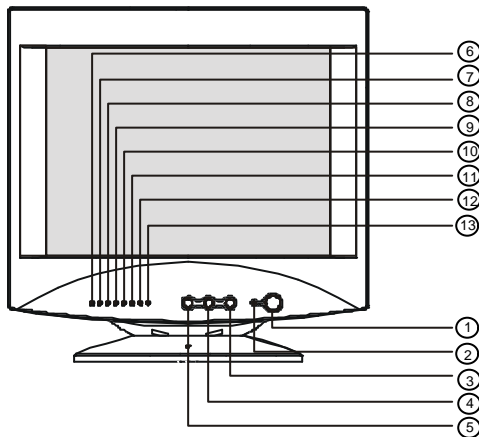

Figure 3 External Control Knob



EXTERNAL CONTROLS

Switch:		Functions:			
1.	Power On/Off Switch	6.	Contrast	11.	V-Center
2.	LED	7.	Brightness	12.	Pincushion
3.	Up Key	8.	H-Size	13.	Trapezoid
4.	Down Key	9.	H-Center		
5.	Function Key	10.	V-Size		

NOTES









- Do not install the monitor in a location near heat sources such as radiators or air ducts , or in a place subject to direct sunlight , or excessive dust or mechanical vibration or shock.
- Save the original shipping carton and packing materials, as they will come in handy if you ever have to ship your monitor.
- For maximum protection, repackage your monitor as it was originally packed at the factory.
- To keep the monitor looking new, periodically clean it with a soft cloth. Stubborn stains may be removed with a cloth lightly dampened with a mild detergent solution. Never use strong solvents such as thinner, benzene, or abrasive cleaners, since these will damage the cabinet. As a safety precaution, always unplug the monitor before cleaning it.

HOW TO ADJUST A SETTING

6. Press the knob, the green LED lights and the power is ON.
Press this knob again, the green LED disappears and the power is OFF.
7. When press the "FUNC" key, the LED will flash to indicate the function has been selected.
8. When function has been selected, press  or  to adjust picture image.
9. Press the Up or Down key to get the optimal volume for the multimedia model only. The most left LED will flash to indicate the adjustable levels have reached to the maximum or minimum.
10. If you press the Func. & Down keys simultaneously it functions as an audio mute, and press Up or Down key to release audio function for multimedia model only.

ADJUSTING THE PICTURE

The description for function control LEDs

1.		CONTRAST	Adjust the picture contrast.
2.		BRIGHTNESS	Adjust the picture brightness.
3.		H-SIZE	Adjust the picture's horizontal size.
4.		H-CENTER	Adjust the horizontal position of the picture.
5.		V-SIZE	Adjust the picture's vertical size.
6.		V-CENTER	Adjust the vertical position of the picture.
7.		PINCUSHION	Adjust the pincushion and barrel.
8.		TRAPEZOID	Adjust the picture's trapezoid distortion.
9.		RECALL	To recall original factory preset mode.

POWER MANAGEMENT FEATURE

The power management feature of this product complies with every power saving requirements of ENERGY STAR® and VESA DPMS when activated, it automatically reduces unnecessary power consumption of the monitor when your computer is not in use.

To use the feature, the monitor needs to be connected to a VESA DPMS computer. There are three power management modes available, these are described below. The required settings, including the timer setting, should be made by the computer.

• Stand-by Mode

When the H-sync signal from the computer is off, the monitor enters into Stand-by Mode which reduces the power consumption to less than 15W. The screen becomes dark, and the power indicator turns to orange. From Stand-by Mode, the screen reappears instantaneously when the keyboard or the mouse is touched again.

- **Suspend Mode**

When the V-sync signal from the computer is off, the monitor enters into Suspend Mode which reduces the power consumption to less than 15W. The screen becomes dark, and the power indicator turns to orange. From Suspend Mode, the screen reappears instantaneously when the keyboard or the mouse is touched again.

- **Active-off Mode**

When both the H and V sync signals from the computer are off, the monitor enters into Active-off Mode which reduces the power consumption to less than 8W. The screen becomes dark, and the power indicator turns to orange. From Active-off Mode, the screen reappears instantaneously when the keyboard or the mouse is touched again.

- The power-saving mode can be indicated by the light-emitting diode (LED) on the front panel:

Mode	Signal				Power	
	Cable	H-Sync	V-Sync	Video	Indicator	Consumption
On*	Attached	Yes	Yes	Active	Green	≤ 90 W
Stand-by	Attached	No	Yes	Blank	Orange	≤ 15 W
Suspend	Attached	Yes	No	Blank	Orange	≤ 15 W
Off	Attached	No	No	Blank	Orange	≤ 8 W

FEATURES

Green monitor

- The monitor has a power saving function that conforms to the VESA DPMS standard. This feature will only work if your PC is a green PC. This feature is similar to a screen saver, except that your monitor will turn it off instead of activating the screen saver.

To activate this feature in Windows[®] 98 :

In Windows[®] 98, this feature can be activated and customized under the screen saver setting of the display properties.

5. Right click on the desktop and choose Properties.
6. Click on the tab that says Screen Saver. If your system supports Green PC, there will be a section entitled "Energy Saving Features of Monitor." If there isn't a section like that, then your PC does not support Green Monitor. The monitor will behave just like a normal monitor, so you will have to turn it off manually to save energy.
7. In the "Energy Saving Features of Monitor" sections are two boxes, Standby and Shut off. To activate either one, click the box next to each one.
8. You can specify the amount of inactive time before your monitor enters standby mode or shuts off.

PLUG AND PLAY

Plug & Play DDC1/2B Feature

This monitor is equipped with VESA DDC1/2B capabilities according to the VESA DDC STANDARD. It allows the monitor to inform the host system of its identity and, depending on the level of DDC used, communicate additional information about its display capabilities. The communication channel is defined in two levels, DDC1 and DDC2B.

The DDC1 is a unidirectional data channel from the display to the host that continuously transmits EDID information. The DDC2B is a bidirectional data channel based on the I²C protocol. The host can request EDID information over the DDC2B channel.

THIS MONITOR WILL APPEAR TO BE NON-FUNCTIONAL IF THERE IS NO VIDEO INPUT SIGNAL. IN ORDER FOR THIS MONITOR TO OPERATE PROPERLY, THERE MUST BE A VIDEO INPUT SIGNAL.

This monitor meets the Power Management standards as set by the Video Electronics Standards Association (VESA) and/or the United States Environmental Protection Agency (EPA) and The Swedish Confederation Employees (NUTEK). This feature is designed to conserve electrical energy by reducing power consumption when there is no video input signal present. When there is no video input signal this monitor, following a time-out period, will automatically switch to an OFF mode. This reduces the monitor's internal power supply consumption. After the video input signal is restored, full power is restored and the display is automatically redrawn. The appearance is similar to a "Screen Saver" feature except the display is completely off. The display is restored by pressing a key on the keyboard, or clicking the mouse.

USING THE RIGHT POWER CORD :

The accessory power cord for the Northern American region is the wallet plug with NEMA 5-15 style and is UL listed and CSA labeled. The voltage rating for the power cord shall be 125 volts AC.

Supplied with units intended for connection to power outlet of personal computer: Please use a cord set consisting of a minimum No. 18 AWG, type SJT or SVT three conductors flexible cord. One end terminates with a grounding type attachment plug, rated 10A, 250V, CEE-22 male

configuration. The other end terminates with a molded-on type connector body, rated 10A, 250V, having standard CEE-22 female configuration.

TECHNICAL SUPPORT (FAQ)

Problem & Question	Possible Solution
Power LED is not on	<ul style="list-style-type: none"> *Check if the Power Switch is in the ON position *Power Cord should be connected
No Plug & Play	<ul style="list-style-type: none"> *Check if the PC system is Plug & Play compatible *Check if the Video Card is Plug & Play compatible *Check if the D-15 plug pin of Video Cable is bent *Make sure the AOC Monitor Drivers are installed (AOC Monitor Drivers are available at: www.aoc-europe.com)
No picture	<ul style="list-style-type: none"> *Computer Power Switch should be in the ON position *Computer Video Card should be snugly seated in its slot *The Signal Cable should be completely connected to the computer *Check the color of the Power LED indicator. If it is orange, then the monitor and the PC system are in power-saving mode. You need press your keyboard or move the mouse to reactivate the system.
Picture is fuzzy	<ul style="list-style-type: none"> *Adjust the Contrast and Brightness Controls.
Picture bounces or a wave pattern is present in the picture	<ul style="list-style-type: none"> *Move electrical devices that may cause electrical interference.
Monitor is stuck in "Power Saving Mode"	<ul style="list-style-type: none"> *Make sure monitor's video cable is properly connected to the computer. *Inspect monitor's video cable and make sure none of the pins are bent. *Make sure computer is operational by hitting the CAPS LOCK key on the keyboard while observing the CAPS LOCK LED. The LED should either turn ON or OFF after hitting the CAPS LOCK key.
Missing one of the primary colors (RED, GREEN, or	<ul style="list-style-type: none"> *Inspect the monitor's video cable and make sure that none of the pins are

BLUE)

bent.

APPENDIX

SPECIFICATIONS

CRT	CRT Size	38.1cm(15"), 90° deflection, 29mm neck
	Viewable Image Size	35.1cm (13.8"), diagonal
	Type	0.28mm dot pitch
Input	Video	0.7Vpp, R,G,B Analog
	Separate Sync.	TTL Level
	H.V. - Sync.	Positive / Negative
Scanning Frequency	H-Frequency	30kHz - 54kHz
	V-Frequency	50Hz-120Hz
Max. Resolution		1024 x 768
Video Dot Rate		65MHz
Factory Preset mode :		5
User Programmable mode :		12
Power Source		Universal AC 100 - 240V, 50Hz / 60Hz
Operating		0° C to 40° C ambient
Humidity		10%to 85%relative, non-condensing
Dimensions	Monitor & Base	360(W) x 362(H) x 387(D)mm
Weight	Unit (net)	11.5kgs (Net)
Signal Cable:		Attached Mini D-sub 15 Male

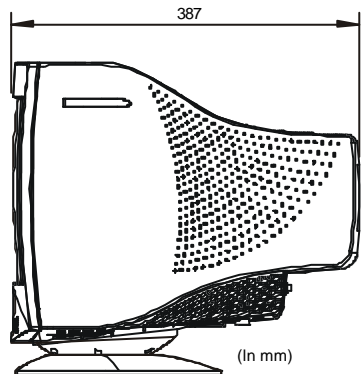
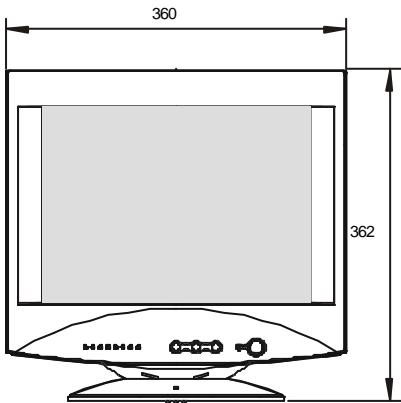

External Controls:	Switch	<ul style="list-style-type: none"> • Power On/Off switch • Up/Down Key • Function Key
	Functions	<ul style="list-style-type: none"> • Contrast • Brightness • H-Size • H-Center • V-Size • V-Center • Pincushion • Trapezoid • Volume (for 5EA/5ElrA only)
Plug & Play		DDC1/2B
Power Management		EPA, VESA DPMS
Power Consumption (Maximum)		90 Watts
Pre-set Display Area		260mm x 195mm
Audio Output (for 5EA/5ElrA only)		Rated Power 1W rms
Regulatory Compliance		UL, CSA, FDA, FCC, TÜV/GS, CE, MPR II (for 5Elr/5ElrA only)

FACTORY PRESET TIMING TABLE

STANDARD	RESOLUTION	HORIZONTAL FREQUENCY	VERTICAL FREQUENCY
IBM	720 x 400	31.47kHz	70Hz
VGA	640 x 480	31.47kHz	60Hz
VESA/85	640 x 480	43.3kHz	85Hz
VESA/85	800 x 600	53.67kHz	85Hz
VESA/60	1024 x 768	48.36kHz	60Hz

CONNECTOR PIN ASSIGNMENT

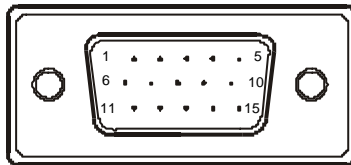

15 - Pin Color Display Signal Cable

PIN NO.	DESCRIPTION	PIN NO.	DESCRIPTION
1.	Red	9.	NC
2.	Green	10.	Ground
3.	Blue	11.	Monitor Ground
4.	Ground	12.	DDC-Serial Data
5.	Ground	13.	H-Sync
6.	R-Ground	14.	V-Sync / *V-Clk
7.	G-Ground	15.	DDC-Serial Clock
8.	B-Ground	*	For DDC

LIMITED THREE-YEAR WARRANTY*

for

AOC Spectrum Color Monitors sold within Europe

AOC International (Europe) GmbH warrants this product to be free from defects in material and workmanship for a period of Three (3) years after the original date of consumer purchase. During this period, AOC International (Europe) GmbH will, at its option, either repair the defective product with new or rebuilt parts, or replace it with a new or rebuilt product at no charge except as *stated below. The defective products that are replaced become the property of AOC International (Europe) GmbH.

If the product appears to be defective, please contact your local dealer or refer to the warranty card when attached to the product.

Deliver the product freight pre-paid, along with the dated proof of purchase, to the AOC Authorized Service Center. If you cannot deliver the product in person:

- Pack it in its original shipping container (or equivalent)
- Put the RMA number on the address label
- Put the RMA number on the shipping carton
- Insure it (or assume the risk of loss/damage during shipment)
- Pay all shipping charges

AOC International (Europe) GmbH is responsible neither for any damage or loss during inbound transport damage nor to inbound product that was not properly packaged.

AOC International (Europe) GmbH will pay the return shipping charges within one of the countries specified within this warranty statement.

AOC International (Europe) GmbH is not responsible for any costs associated with the transportation of product across international borders. This includes the international border within the European Union.

* This limited warranty does not cover any losses or damages that occur as a result of

- Shipping or improper installation or maintenance
- Misuse
- Neglect
- Any cause other than ordinary commercial or industrial application
- Adjustment by non-authorized source
- Repair, modification, or installation of options or parts by anyone other than an AOC Authorized Service Center
- Improper environment
- Excessive or inadequate heating or air conditioning or electrical powers failures, surges, or other irregularities

This limited warranty does not cover any of the product firmware or hardware that you or any third party have modified or altered; you bear the sole responsibility and liability for any such modification or alteration.

ALL EXPRESS AND IMPLIED WARRANTIES FOR THIS PRODUCT (INCLUDING THE WARRANTIES OF MERCHANTABILITY AND FITNESS FOR A PARTICULAR PURPOSE) ARE LIMITED IN DURATION TO A PERIOD OF THREE (3) YEARS FOR PARTS AND LABOR FROM THE ORIGINAL DATE OF CONSUMER PURCHASE. NO WARRANTIES (EITHER EXPRESSED OR IMPLIED) APPLY AFTER THIS PERIOD.

AOC INTERNATIONAL (EUROPE) GMBH OBLIGATIONS AND YOUR REMEDIES HEREUNDER ARE SOLELY AND EXCLUSIVELY AS STATED HERE. AOC INTERNATIONAL (EUROPE) GMBH LIABILITY, WHETHER BASED ON CONTRACT, TORT, WARRANTY, STRICT LIABILITY, OR OTHER THEORY, SHALL NOT EXCEED THE PRICE OF THE INDIVIDUAL UNIT WHOSE DEFECT OR DAMAGE IS THE BASIS OF THE CLAIM. IN NO EVENT SHALL AOC INTERNATIONAL (EUROPE) GMBH BE LIABLE FOR ANY LOSS OF PROFITS, LOSS OF USE OR FACILITIES OR EQUIPMENT, OR OTHER INDIRECT, INCIDENTAL, OR CONSEQUENTIAL DAMAGE. SOME STATES DO NOT ALLOW THE EXCLUSION OR LIMITATION OF INCIDENTAL OR CONSEQUENTIAL DAMAGES, SO THE ABOVE LIMITATION MAY NOT APPLY TO YOU. ALTHOUGH THIS LIMITED WARRANTY GIVES YOU SPECIFIC LEGAL RIGHTS, YOU MAY HAVE OTHER RIGHTS, WHICH MAY VARY FROM COUNTRY TO COUNTRY. THIS LIMITED WARRANTY IS ONLY VALID FOR PRODUCTS PURCHASED IN THE MEMBER COUNTRIES OF THE EUROPEAN UNION.

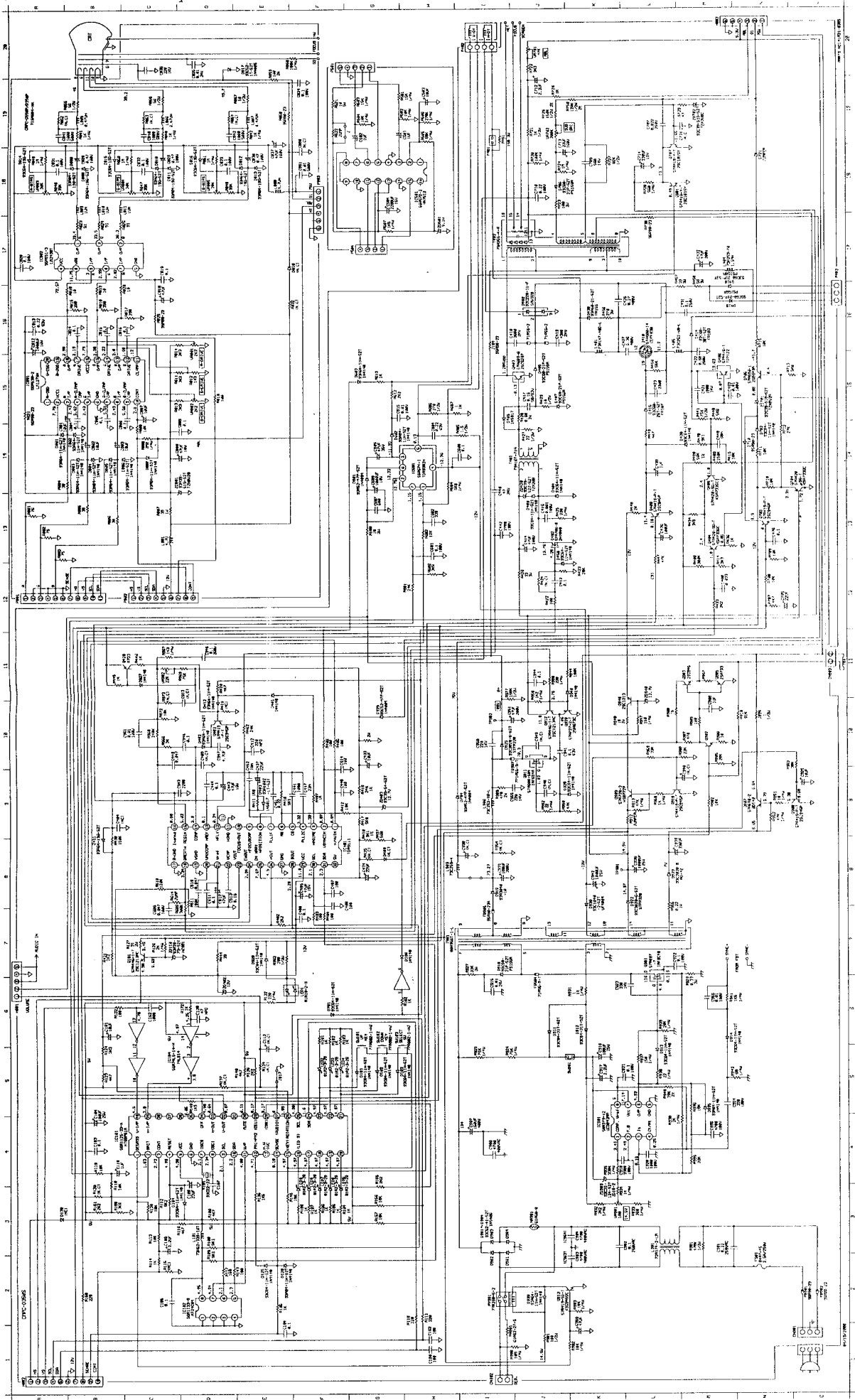



9. BLOCK DIAGRAM (DEFLECTION AND VIDEO)

